

EUROTHERM

Miniature dual output temperature limit switch



UL Model 93

- Approved by Factory Mutual Research Corp.
- Compact—less than 2" square (fits 1/16 DIN cutout)
- 2 independent alarm output channels: form C and form A relay outputs
- Each channel configurable to one of 6 different alarm functions
- Latching operation
- Reset by external pushbutton or at front panel
- Alarm test feature for proving out alarm systems
- All set-up and configuration parameters adjustable and securable from front panel without use of jumpers or links

- Sensor break and power fail alarm indications
- Choice of 11 types of thermocouples, RTD or linear input
- Operation in °F, °C or process units
- Linear input with choice of scaling procedures
- Integral mounting sleeve
- 3-button operation with protection of critical parameter values from accidental modification
- Designed for worldwide safety compliance
- Splash-proof NEMA 3 (IP-54) front panel wipes clean



The Model 93 is a full-featured temperature limit switch that provides affordable, back-up protection for plant equipment and personnel. The high reliability and integrity built into the Model 93 make it the solution to growing requirements for temperature and process limit switches.

Eurotherm's design and manufacturing of the Model 93 combine the latest technology and exceptional engineering to produce a limit switch that satisfies a wide range of uses. A single universal version of the instrument enables the user to quickly set it up from the front panel for the specific application. Even with this flexibility, the user interface remains clear and straightforward while providing protection from inadvertent parameter changes.

The technologies implemented by Eurotherm offer significant benefits for the engineer and operator alike:

Wide viewing angle. Low reflectance touch sensitive front panel provides high visibility under bright and dim lighting conditions.

Long-life reliability. Surface-mount printed circuit boards are assembled, quality-checked and tested in Eurotherm's own surface-mount facility.

Brownout immunity. Switchmode power supply handles worldwide line voltages between 100 and 240Vac (+10,-15%).

Increased shock and vibration resistance. Quality precious metal interconnection technology eliminates hand-soldered wiring.

The Model 93 is completely engineered and manufactured in the United States by Eurotherm and is covered by a 2-year warranty.

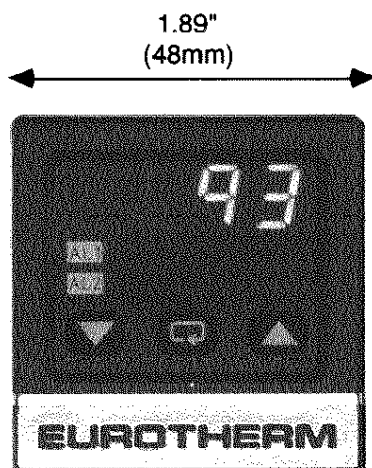

Actual size
Fits into 1.77" square cutout.

Process related safety features

Failsafe alarm operation

Each channel of the Model 93 can be configured to act upon one of 5 input alarm conditions (see Specification). The relay outputs are failsafe (relay de-energized during an alarm condition).

Red annunciation LEDs on the front panel flash whenever the measured value is in an alarm condition, and are OFF when the measured value is in the safe condition. A third state, where the LEDs shine steady ON, signifies that the operator has acknowledged the alarm either through a front panel procedure (see Operation), or with a remote pushbutton connected to the rear terminals.

Sensor fail alarm

If the limit switch detects that the sensor circuit has failed, then the annunciation SnSr FAIL is displayed and the output relays (if enabled) go into the alarm state. The sensor fail alarm behaves like a latching alarm and requires operator attention.

Power fail alarm

The Model 93 can be configured to place both output relays into the alarm state upon powering up after a power failure. If this type of operation is not selected, the unit still remembers the alarm(s) existing before the power failure and appropriately sets the relays and the LEDs.

Alarm test

This feature allows the user to independently test the output relays of the alarm unit and to verify proper operation of the external circuit.

Built-in safety features

Eurotherm has designed and manufactured the Model 93 to comply with North American and European fire and electrical safety standards. The plastic components are manufactured from flame retardant materials. The limit switch dissipates less than 5 watts, minimizing its contribution to enclosure temperature rise.

Robust connection system

The pressure plates on rear terminal screws protect against wire pullout and are vibration resistant. Two different diameter wires can be safely connected to one terminal screw without danger of one falling out. Wire sizes up to #12/AWG can be accommodated.

Foolproof user interface

In addition to being easy to use, the user interface minimizes button pushing while providing adequate protection for control parameter values and configuration. Each button push is accompanied by appropriate visual indication.

Parameter security

The limit switch configuration and parameter values are stored in non-volatile EEPROM. This memory provides data retention for the life of the unit with or without power applied. When the unit is powered up, it performs a self test to verify that all the memories and internal electronics are operating properly before monitoring the input signal.

Limit switch configuration

Configuring the limit switch sets up the instrument for the intended application. The user can specify the alarm functions, input type and range, display units, control type, etc. This information is presented in a 4-digit configuration code (the same as in the Product Code on the back page) viewable in the display for a few seconds after the instrument is powered up or on demand. The operator can modify the settings at this time if required. Configuring the Model 93 takes less than a minute.

Mechanical features

Neat, clean-cut design throughout is the hallmark of the Model 93. The trim, uncluttered front panel design enhances control panel installations and is easy to keep clean.

Installation of the Model 93 is a simple procedure. The panel mounting clip simply slides on from the rear. The rear terminal pressure plates rise up with the screw heads for fumble-free wire insertion in tight installations. Spade lugs are not required.

Linear inputs

The Model 93 offers 2 methods for entering and scaling linear inputs to accommodate various types of input sensors. The first method, "Linear a," involves entering coordinates for the 2 scaling points. The other, "Linear b," requires entering coordinates for only one point and then a span. With both methods, the unit can directly read the actual input signal, or the user can enter the equivalent signal value with the front panel pushbuttons.

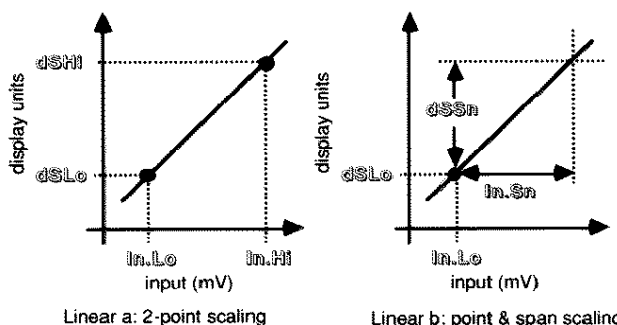

Accessories

FRONT PANEL GASKET made of closed-cell neoprene seals the installation to NEMA 3 (IP-54).

REAR TERMINAL COVER prevents direct contact with electrical connections (IP-20 behind-panel rating).

RC SNUBBER NETWORK is available for relay outputs when driving inductive loads.

INPUT SHUNT RESISTOR connects across the input terminals for utilizing the linear input with milliamp signals.





Operation

When the Model 93 is unattended, the display indicates the measured value. Depending on the configuration, the display units can be °F, °C, or process units. The icons behind the three pushbuttons are extinguished.





If the measured value enters an alarm condition, the red "AL1" annunciation flashes and the alarm is affirmed (relay de-energized). In the example here the alarm 1 channel is configured as a "full scale" high alarm.





One touch on  displays the units and lights up the front panel buttons:  (increment),  (decrement), and  (next parameter).



Another touch displays AL 1, the alarm 1 setpoint. Pushing on  or  reveals the value of the setpoint. For security, the setpoint cannot be modified here.





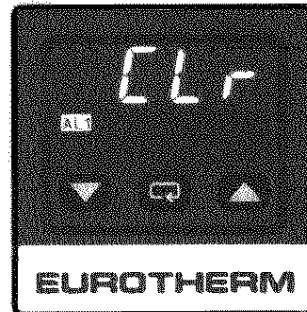

To acknowledge the alarm, hold down on either  or  for several seconds until CLR appears, release, then depress the button again. The red annunciator stops flashing and remains steady ON. The light will go out and the relay will re-energize when the measured value enters the "safe" condition.



By touching a fourth unmarked, "secret" button on the front panel when the process units (°F, °C or Lin) are displayed, the *protected* list can be accessed. This list contains parameters for setting the alarm setpoints, adjusting the hystereses, and testing the output relays. The parameter shown here, HY 1, is the hysteresis for the alarm 1 channel.



By touching  or  the value of the parameter is displayed, and by using  or  again, the value can be modified. The display returns to the measured value if the operator lets the display time out for about 10s.



Other parameters in the protected list include:
 Conf—Configuration code (read only)
 Id—Model number of the instrument
 dP—Decimal point position (linear inputs only)
 AL 1—Alarm 1 setpoint
 HY 1—Alarm 1 hysteresis
 -d-1—Alarm 1 deviation (deviation configuration only)
 AL 2—Alarm 2 setpoint
 HY 2—Alarm 2 hysteresis
 -d-2—Alarm 2 deviation (deviation configuration only)
 OFST—Input offset
 Line—Line frequency...
 plus several parameters for scaling linear inputs.

Specifications

1. INPUTS

All inputs

Sampling frequency

Maximum common-mode voltage @ 50/60Hz

Common mode rejection @ 50/60 Hz

Series mode rejection @ 50/60 Hz

Thermocouple inputs

Number of thermocouple types

Calibration accuracy (maximum error)

For temperatures > 0°C

For temperatures < 0°C

Cold junction compensation rejection ratio

Maximum thermocouple loop resistance with no effect on reading

Resistance temperature detector input

Device

Resistance at 0°C

Resistance at 100°C

Calibration accuracy (maximum error)

Maximum lead resistance with no effect on reading

Excitation current

Linear input

Range

Maximum source impedance, including leads

Calibration accuracy (maximum error)

Scaling methods

Entry of input signal scaling points

Maximum recommended scaling

2. OUTPUT RELAYS

Output configurations

Alarm 1

Alarm 2

Maximum load voltage

Maximum load current (resistive load)

Minimum load voltage

Relay action

Relay drive signal source

Output test (for each output relay)

3. ALARM TYPES

Measured value

Number of independent selectable alarm input functions

Number of alarm functions assignable to each alarm relay output

Hysteresis adjustment range (for each channel)

Temperature units

Process units

Annunciation during alarm condition

Sensor break

Alarm condition

Maximum reaction time (for $R_{in\ break} \geq 10k\Omega$)

Annunciation during alarm condition

Power fail (selectable with latching operation only)

Alarm condition

Annunciation after power failure

Acknowledgement and reset

4. ALARM MEMORY

Operation

5Hz

264V_{ac rms} (with respect to supply terminals)

≥120dB (with respect to supply terminals)

≥60dB

11 (B, C, E, J, K, L, N, PL2, R, S, T)

See Input Sensors table

±0.25% of reading ± total offset error ± 0.5 l.s.d.

where total offset error (°C) = 0.25°C + ($\alpha_{25} + 12$)/ α_T

and α_{25} (μV/°C) = Seebeck coefficient at 25°C

α_T (μV/°C) = Seebeck coefficient at input temperature

15:1 (with internal detector)

1000Ω

DIN 43760/BS 1904 (100Ω Pt), 3-wire connection

100Ω

138.5Ω

±0.25% of reading ±1.0°C ±0.5 l.s.d.

20Ω/lead

225μA

-10 to 70mV

1000Ω

±0.25% of reading ±12μV ±0.5 l.s.d.

Non-interactive 2-point scaling, or single point and span

Reading of actual signal, or entry through front panel

1 l.s.d. ≥ 10μV

Form C, isolated

Form A, isolated

264V_{ac rms}

2A_{rms}

10V_{peak}

Failsafe (alarm state affirmed by de-energized relay)

Independently selectable from one of the 5 measured value alarms, sensor break alarm, or disabled.

Front panel pushbutton sequence momentarily toggles relay from current state.

5, ("Full-scale" high, "Full-scale" low, deviation high, deviation low or deviation band)

1

1°C or 1°F to upper range limit

1 process unit l.s.d. to upper range limit

Flashing red "AL1" or "AL2" light as appropriate.

Lamp becomes steady ON when acknowledged but not yet cleared.

Input open or measured value > +90mV or < -40mV

15s

Flashing display: Snsr alternating with FAIL

Loss of power to alarm unit

Normal startup sequence, then flashing red "AL1" and/or "AL2" lights (for enabled outputs only)

Front panel pushbutton sequence, or momentary contact pushbutton connected to rear terminals.

Alarm annunciation disappears and relay re-energizes only if alarm condition has cleared *and* operator has acknowledged

alarm by resetting channel. Order of operations unimportant. Alarms existing before a power failure are reaffirmed upon power reinstatement. Front panel pushbutton sequence, or momentary contact pushbutton connected to rear terminals. 25,000 operations

Configurable to channel 1 and /or channel 2. Momentarily shorting reset terminals. 50Ω 15mA 12V

See below. 0.36" (9.3mm) Switchmode 100-240V_{ac rms}, +10/-15% 48-52Hz or 58-62Hz Less than 5W

0-55°C Better than 100ppm of input span/°C 25°C 5-95%, non-condensing NEMA 3 (IP-54) with optional front panel gasket

Reset (acknowledgement) methods

Maximum number of latching

Reset input

Assignment

Reset action

Maximum contact resistance

Required short circuit current

Nominal terminal voltage

5. GENERAL

Overall dimensions

LED character height

Power supply

Line voltage range

Line frequency range

Power dissipation

Environmental considerations

Operating temperature range

Ambient temperature coefficient

Calibration reference temperature

Relative humidity

Fascia seal rating

Input sensors

	Display range				Calibration accuracy specification					Key
	°C		°F		Range		Accuracy		(see key at right)	
	Min.	Max.	Min.	Max.	°C	°F	Min.	Max.		
Thermocouples										
B—Pt-30%Rh/Pt-6%Rh	600	1820	1112	3308	600	999	1112	1831	B	A = ±0.25% of reading ±1.5°C ±0.5 l.s.d.
					1000	1820	1832	3308	A	
C—W-5%Re/W-26%Re (Hoskins)	0	2150	32	3902	0	2150	32	3902	B	B = ±0.25% of reading ±2.5°C ±0.5 l.s.d.
E—Chromel™/Adams constantan	-260	1000	-436	1832	-260	-1	-436	31	*	C = ±0.25% of reading ±3.5°C ±0.5 l.s.d.
					0	1000	32	1832	A	
J—Fe/SAMA constantan	-200	1200	-328	2192	-200	-1	-328	31	*	* See Specification §1
					0*	1200	32	2192	A	
K—Chromel™/Alumel™	-250	1372	-418	2502	-250	-1	-418	31	*	
					0	1372	32	2502	A	
L—Fe/Konstantan	-100	900	-148	1652	-100	-1	-148	31	*	
					0	900	32	1652	A	
N—NiCroSil/NiSiil	0	1300	32	2372	0	1300	32	2372	B	
Platinel II™	-250	1395	-418	2543	-250	-1	-418	31	*	
					0	1395	32	2543	A	
R—Pt-13%Rh/Pt	0	1767	32	3213	0	399	32	750	C	
					400	1767	751	3213	B	
S—Pt-10%Rh/Pt	0	1767	32	3213	0	399	32	750	C	
					400	1767	751	3213	B	
T—Cu/Adams constantan	-255	400	-427	752	-255	-1	-427	31	*	
					0	400	32	752	A	
RTD—100Ω Pt DIN43760/BS1904	-100	600	-148	1112	-100	600	-148	1112	*	
	Min.	Max.	Min.	Max.	Min.	Max.	Min.	Max.		
Linear		-999	9999		-999	9999		-		
		-99.9	999.9		-99.9	999.9		-		
		-9.99	99.99		-9.99	99.99		-		

Dimensions

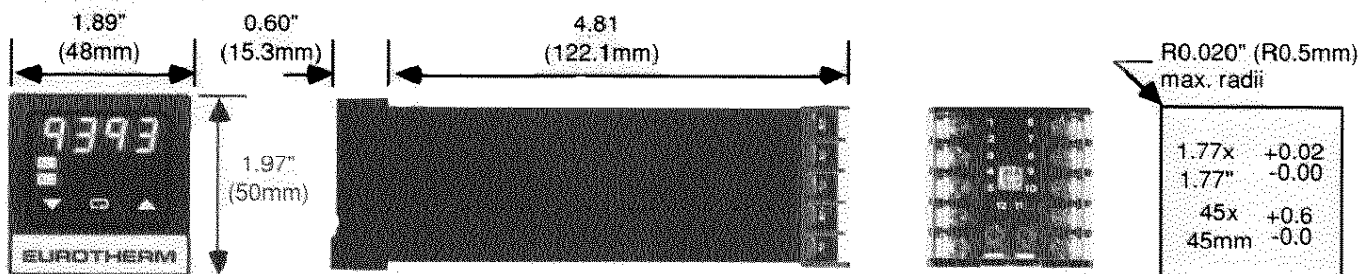

Panel depth: with rear terminal cover: 4.96" (126.1mm)
with gasket fitted: less 0.060" (1.5mm)

Panel cutout
Max. panel thickness:
0.51" (13mm)

Rear terminal connections

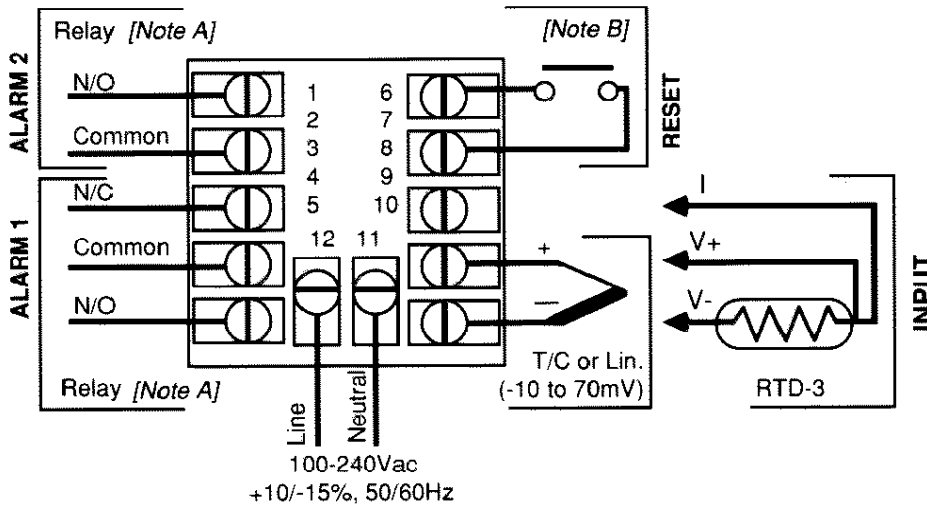

NOTES:

- A. N/C and N/O refer to the condition of the relay contacts when the relay is not energized; i.e. when the relay is in the alarm condition or when power is not applied to the limit switch.
- B. Optional momentary contact pushbutton for alarm reset. The reset input is not isolated from the measurement input and must NEVER be connected to ground or to any other circuit.

Product code

HARDWARE CODE [1] CONFIGURATION CODE [1]

Model	3rd output	nameplate	alarm 1 function	alarm 2 function	sensor type	disp. units, remote ack. & pwr fail alm
93	0					

Coding:

HARDWARE CODE: [1]

third output

0	None
---	------

nameplate

0	Standard Eurotherm Logo
@...	Custom logo [2]

CONFIGURATION CODE: [1]

alarm 1 and alarm 2 functions

0	Disabled
1	Deviation low alarm
2	Deviation high alarm
3	Deviation band alarm
4	Full scale low alarm
5	Sensor break alarm
6	** Full scale high alarm

input sensor type

0	RTD—100Ω Pt. DIN43760/BS1904
1	B—Pt-30%Rh/Pt-6%Rh
2	C—W-5%Re/W-26%Re (Hoskins)
3	E—Chromel™/Adams constantan
4	J—Fe/SAMA constantan
5	K—Chromel™/Alumel™
6	L—Fe/Konstantan
7	N—NiCroSil/NiSil
8	Platinel II™
9	R—Pt-13%Rh/Pt
A	S—Pt-10%Rh/Pt
B	T—Cu/Adams constantan
C	Linear a—2-point entry scaling
D	Linear b—point-and-span entry scaling

disp. units, remote ack., power fail alarm [3]

	disp.	remote ack.	pwr fail alarm
0	°C	AL1 & 2	no
1	°C	AL1 & 2	yes
2	°C	AL1	no
3	°C	AL1	yes
4	°C	AL2	no
5	°C	AL2	yes
6	* °F	AL1 & 2	no
7	°F	AL1 & 2	yes
8	°F	AL1	no
9	°F	AL1	yes
A	°F	AL2	no
B	°F	AL2	yes

ACCESSORIES:

CZ140398	RC snubber network [4]
BO133297	1/16 DIN front panel gasket
BD133125	Rear terminal cover [5]
FY133264U001	Rear term. cvr screw [5]
CA9G3R01	Input shunt resistor [6]

NOTES:

1. The complete Product Code consists of both the Hardware and the Configuration Codes. The standard Configuration Code (6646) is indicated in the tables by asterisks (*).
2. Custom logo nameplates are available. For quantity considerations, consult factory.
3. Display units selection apply only to temperature inputs—selection irrelevant for linear inputs.
4. External RC snubber network required across relay contacts when driving AC inductive loads (mechanical contactors and solenoids). DO NOT USE SNUBBERS WHEN DRIVING HIGH IMPEDANCE LOADS!
5. Order rear terminal covers and screws in sets. One screw and cover required per unit.
6. 3.01Ω, 1%, 0.25W, ±100ppm resistor required for 4-20mA or 0-20mA inputs.

Subject to change without notice.
© 1991 Eurotherm Corporation.



EUROTHERM CORPORATION
A Eurotherm International Company

11485 Sunset Hills Road, Reston, Virginia 22090-5286

(703) 471-4870
Facs (703) 437-3184
BBS (703) 471-5446
Telex 89-9449