



**Power
Thyristor Units**



**Two phase
load control**



**Invensys
EUROTHERM**

User Manual

7200A ADVANCED CONTROLLERS

THYRISTOR UNITS CONTROLLING TWO PHASES OF A THREE-PHASE LOAD

7000 SERIES

USER MANUAL

© Copyright Eurotherm Automation 2004

All rights reserved. All reproduction or transmission in any form whatsoever and using any procedure (electronic or mechanical, including photocopying and recording) without written permission from Eurotherm is strictly prohibited

COMMISSIONING FLOWCHART

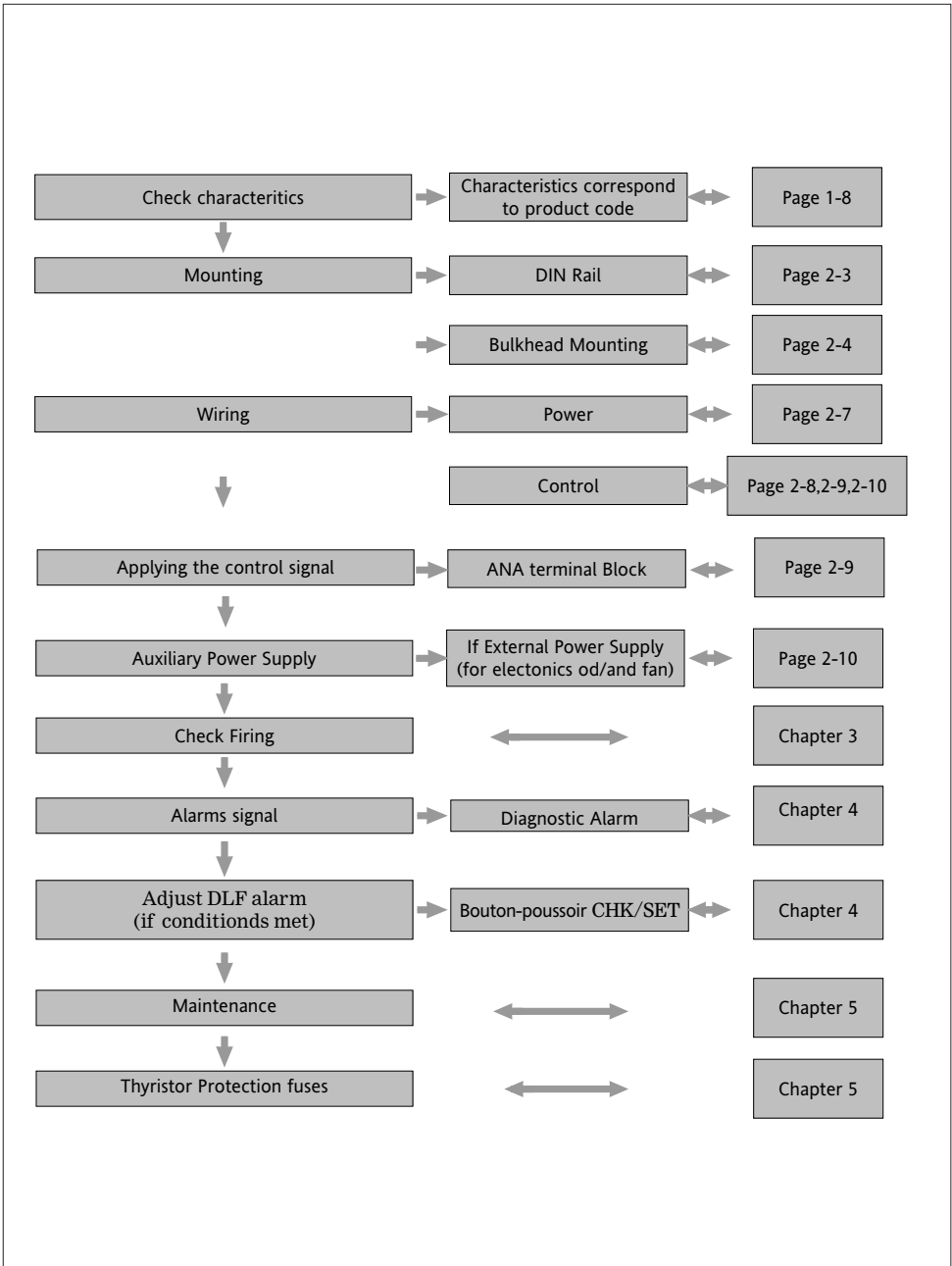

CONTENTS

	Page
Commissioning flowchart	ii
European Directives and applicable standards	iv
Chapter 1 Identification of power thyristor units	1-1
Chapter 2 Installation	2-1
Chapter 3 Firing modes	3-1
Chapter 4 Alarms	4-1
Chapter 5 Maintenance	5-1
Index	6-1
Eurotherm worldwide sales and services	7-1

PURPOSE OF MANUAL

This manual (Issue **3.0**) describes the Basic Version and all Options for 7200A series three-phase power thyristor units.

Eurotherm's policy of continuous product improvement and development means that the specifications in this document may be modified without prior notice.

EUROPEAN DIRECTIVES AND APPLICABLE STANDARDS

COMPLIANCE WITH PRODUCT STANDARD

7200A products comply with the terms of product standard **EN 60947-4-3**

'Contactors and motor-starters - AC semiconductor controllers and contactors for non-motor loads'.

CE LABELLING

7200A products installed and used in accordance with the user manual, bear CE labelling on the basis of compliance with the essential requirements of the **European Low Voltage Directive** 73/23 EEC dated 19 February 1973, modified by 93/68/EEC dated 22 July 1993 and the **Electromagnetic Compatibility Directive** 89/336/EEC dated 3 May 1989 modified by 92/31/EEC dated 28 April 1992 and 93/68/EEC dated 22 July 1993.

SAFETY

The units have IP20 protection rating as defined by standard IEC 60529.

External wiring must comply with standards IEC 60364-4-43 and IEC 60943.

Copper cables and conductors must be used, rated to a temperature of 75°C (167°F).

ELECTROMAGNETIC COMPATIBILITY (EMC)

7200A products installed and used in accordance with the user manual, are designed for an industrial environment and must not be used in the home.

IMMUNITY

The EMC **immunity test standards** required by the standard EN 60947-4-3

'Contactors and motor-starters - AC semiconductor motor controllers and contactors for non-motor loads' are presented in table 1.

Test type	Minimum levels	EMC test standard
Electrostatic discharge	4 kV on contact; 8 kV in air	EN 61000-4-2
Radiated, radio frequency electromagnetic field	10 V/m 80 MHz $\leq f \leq$ 1 GHz; 80% modulation 1 kHz sinusoidal	EN 61000-4-3
Electrical fast transient / burst	2 kV / 5 kHz	EN 61000-4-4
Electrical surge	4 kV line to earth; 2 kV line to line	EN 61000-4-5
Conducted disturbances	140 dB μ V; 150 kHz $\leq f \leq$ 80 MHz	EN 61000-4-6
Voltage dips, short interruptions and voltage variation	5 s interruptions	EN 61000-4-11

Table 1. EMC immunity standards compliance

EMISSIONS

The EMC **emissions test standards** required by the standard EN 60947-4-3

'Contactors and motor-starters - AC semiconductor motor controllers and contactors for non-motor loads' are presented in table 2.

Emission type	Firing mode	Test standard
Radiated at radio frequencies	All firing	CISPR 11 modes Class A
Conducted at radiofrequencies	'Burst mode' and 'Single-cycle'	CISPR 11 Class A group 2

Table 2. EMC emissions standards compliance

EMC GUIDE

To help you deal with installation-dependent electromagnetic interference effects, Eurotherm provides an 'Electromagnetic compatibility' installation guide (ref. HA 025464 ENG) which sets out best current practice regarding EMC.

CE CONFORMITY DECLARATION is available on request.

1. Chapter 1

POWER THYRISTOR UNIT IDENTIFICATION

Contents	Page
1.1. General presentation	1-2
1.2. Technical specifications	1-5
1.2.1. Use	1-5
1.2.2. Power	1-5
1.2.3. Load	1-5
1.2.4. Dimensions	1-5
1.2.5. Command	1-5
1.2.6. Firing modes	1-6
1.2.7. Control	1-6
1.2.8. Indication	1-6
1.2.9. Alarms	1-6
1.2.10. Protection	1-7
1.2.11. Mounting	1-7
1.2.12. Environment	1-7
1.3. Coding	1-8

1. Chapter 1 IDENTIFICATION

1.1. GENERAL PRESENTATION

A 7200A series thyristor unit comprise of two channel, controlled by thyristors.

7200A series thyristor units are used to control the electrical power of three-phase industrial loads ; such as :
 Low coefficient resistive loads
 Short wave infrared elements for units with a rating ≤ 100 A

Current ratings vary from 16 A to 200 A (per phase), at line-to-line voltages from 200 V to 500 V

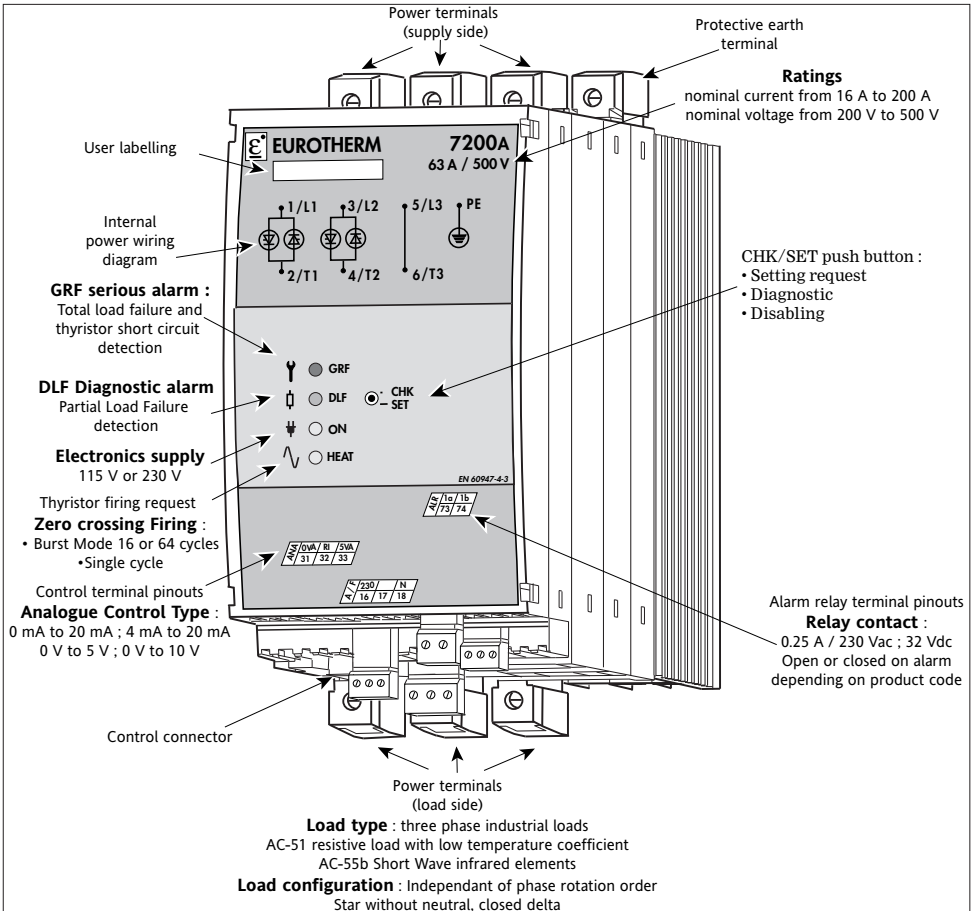

Figure 1-1 General view of a 7200A power unit ratings from 16 A to 63 A

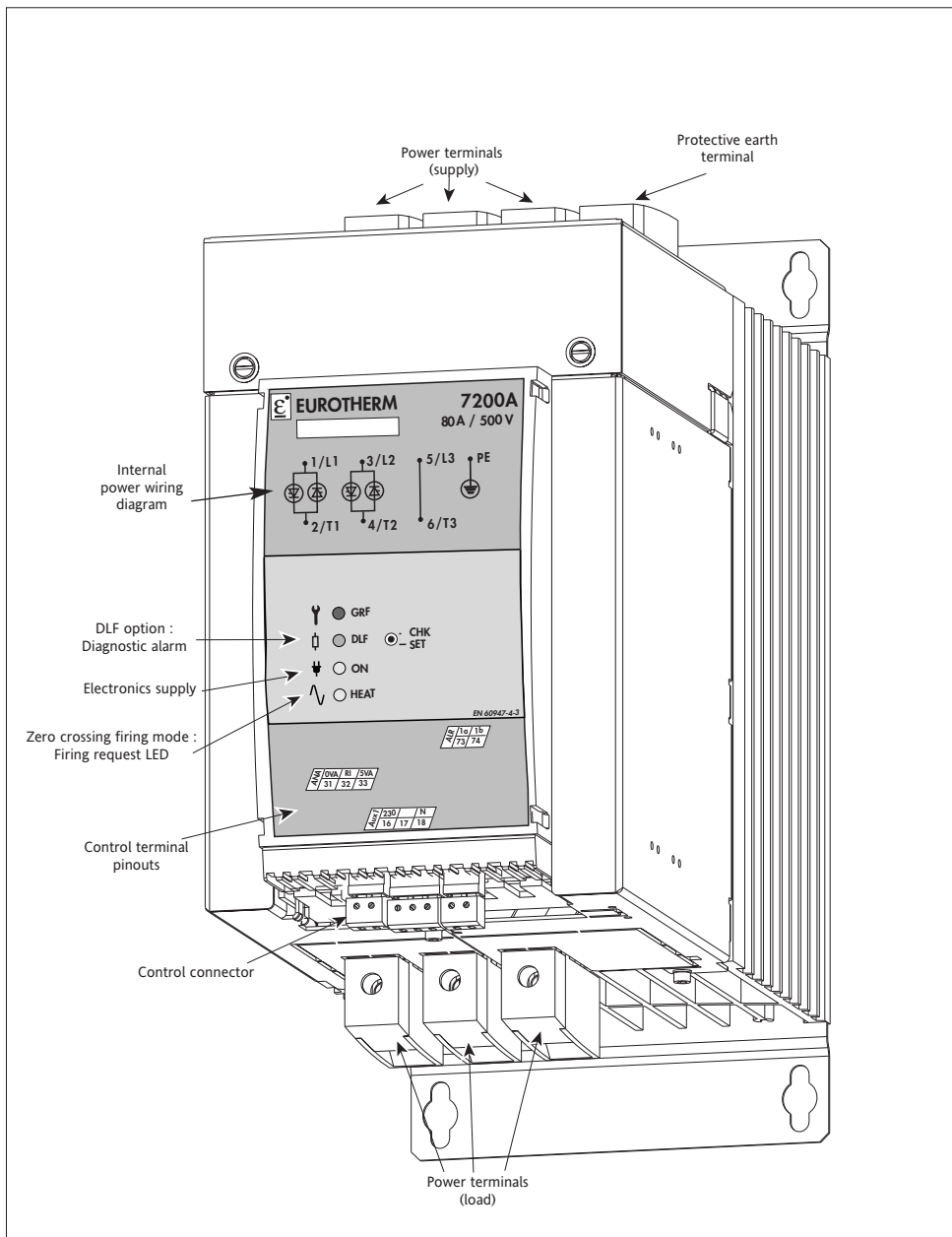

Figure 1-2 General view of a 7200A power unit ratings from 80 A to 100 A

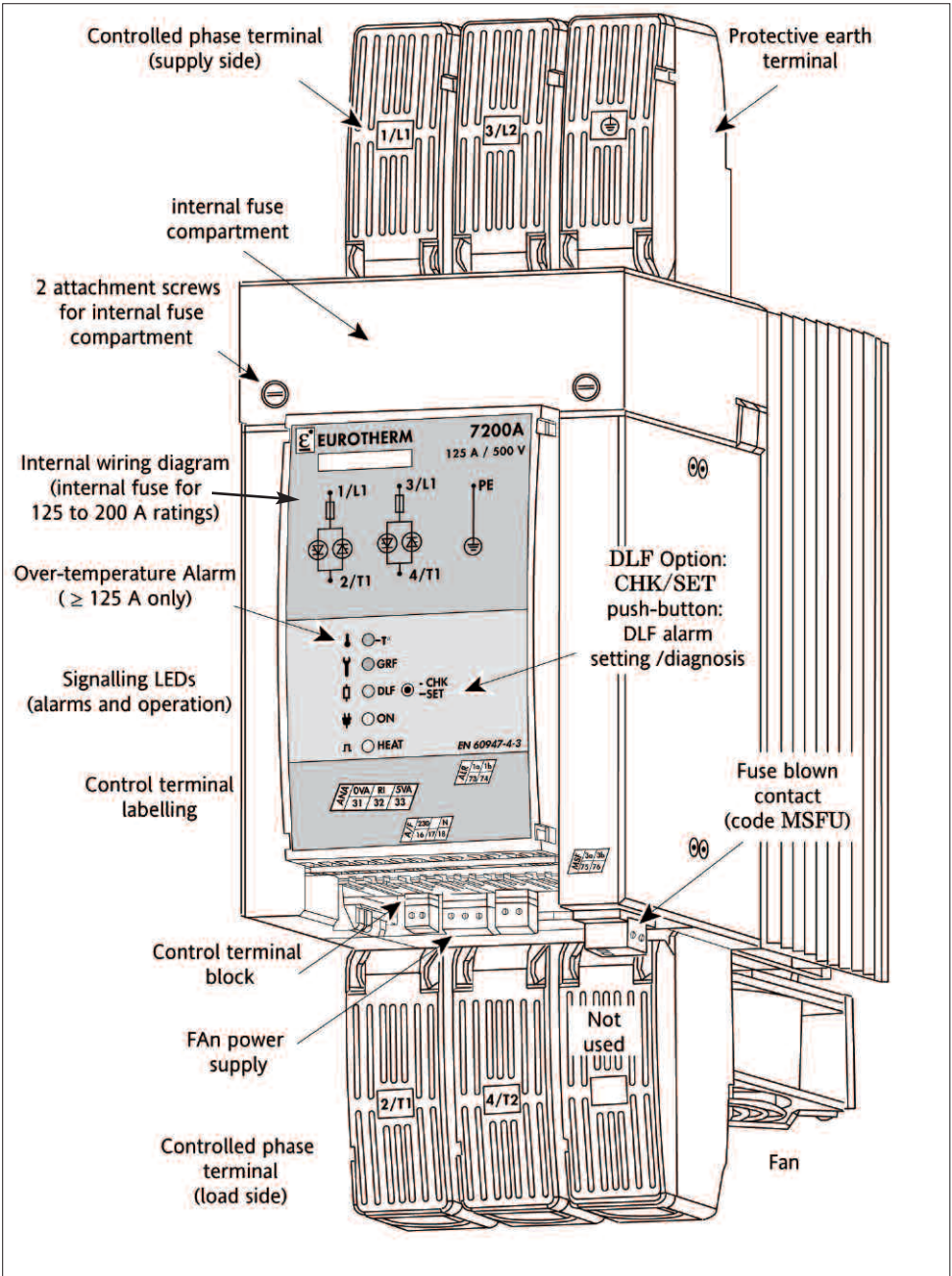

Figure 1-3 General view of a 7200A power unit ≥ 125 A rating

1.2. TECHNICAL SPECIFICATIONS

1.2.1 Use

Thyristor unit, variant 4 (see Standard EN 60947-4-3) for uninterrupted service.

1.2.2. Power

Nominal current per phase
Nominal line to line voltage
Frequency
Dissipated power
Cooling

16 A to 200 A at 45 °C (see product code)
200 V to 500 V (see code).
Use from 47 to 63 Hz (automatic matching)
1,3 W (approx.) per amp and per phase
Ratings ≤ 100 A : Natural convection
Ratings ≥ 125 A : Fan-cooled.
115 V or 230 V ; consumption 10 VA.

1.2.3. Load

Categories of use

Industrial three-phase load, three-wire configuration.
The categories of use applicable for each unit are indicated on the identification label.

- AC-51 Non-inductive or low inductance loads, furnace resistances. (resistive load with low temperature coefficient)
 - AC-55b Switching of incandescent lamps
(Short wave infrared elements, SWIR) for ≤ 100 A units
Options must be fitted to 7200A units in order to comply with certain categories of use.
- Load configuration
Independant of phase rotation order
Star without neutral, closed delta. (Configuration on order)

1.2.4. Dimensions

Rating	Height	Width	Depth (mm)	
			Basic	DLF
16 A à 63 A	220 mm	96 mm	214	264
80 A à 100 A	305 mm	144 mm	372	372
125 A à 200 A	495 mm	144 mm	372	372

1.2.5. Command

Supply

Self-powered from line or external power supply
(115 V or 230 V +10%; -15%, see code). Consumption : 10 VA

Command type

Analogue

- Either remote analogue setpoint :
0-5V or 0-10V (100 kΩ input)
0-20mA or 4-20mA (250 Ω i/p)
- or manual setpoint (potentiometer) : 0-5V (2 mA max).

1.2.6. Firing modes

Zero crossing firing

- ‘Burst mode’, base time : 16 or 64 cycles
- ‘Single-cycle’, base time : 1 cycle

1.2.7. Control

Parameters

- Standard (on balanced three-phase supply) :
Load voltage squared (V^2)

Linearity and Stability

Better than $\pm 2\%$ of full scale
(on balanced three-phase supply)

1.2.8. Indication

Electronic supply present Green ‘ON’ LED and supply fault detection : ‘ON LED flashing’
Thyristor firing request : Green ‘HEAT’ LED

1.2.9. ALARMS

Serious alarms (*GRF*)
(if DLF Option)

Total load failure and thyristor short circuit detection.

Signalling

Red ‘GRF’ LED and alarm relay contact

Diagnostic alarm (*DLF*)

Partial Load Failure detection.

Signalling

Orange ‘DLF LED and alarm relay contact’.

Settings

Monitoring diagnosis, alarm adjustment and resetting using push button on front pannel.

Sensitivity

Detects the failure of at least one heating element for several identical elements, connected in parallel.

Load configuration	3D	3S
FC1	1/2	1/3
C16, C64	1/3	1/4

Extension

The DLF option includes Serious alarm monitoring (GRF)
Partial Load Failure detection for SWIR loads is only available when using FC1 Burst firing mode

Over-temperature alarm

For all fan-cooled units (≥ 125 A, available later), the unit cuts out if the temperature threshold is exceeded.

Signalling

Red ‘T °’ LED Alarm relay contact with any alarm.

Alarm relay

Available with DLF option.

The relay contact (0,25 A/230 Vac; 32 Vdc) is either open on alarm or closed on alarm depending on the product code.

1.2.10. Protection

Co-ordination type	For short circuits.
Electrical protection	IP20 without adding additional protection.
Thyristors	Varistor and RC snubber.
	Quick-acting three-phase fuses :
	• rating ≤ 100 A : external (order separately)
	• rating ≥ 125 A : internal.
	No fuse for short wave infrared elements

1.2.11. Mounting

Mounting	Attachment plate fixed to unit :
	• On symmetrical EN50022 DIN rail or
	• bulkhead mounting
	(for ratings ≥ 80 A : bulkhead mounting only).

1.2.12. Environment

Use	From 0 to 45 °C at nominal current, max. altitude 1000 m
Storage	From -10 °C to 70 °C.
Isolation voltage	Assigned isolation voltage $V_i = 500$ V.
Pollution	Degree 2 acceptable (as defined by IEC 60664).
Humidity	RH from 5% to 95% non-condensing, non-streaming.
Over-Voltage	Over-voltage category II (as defined by IEC 60664)

1.3. Codification

Ratings

1. Nominal current per phase	Code
16 amps	16A
25 amps	25A
40 amps	40A
63 amps	63A
80 amps	80A
100 amps	100A
125 amps	125A
160 amps	160A
200 amps	200A

2. Nominal line to line voltage	Code
200 volts	200V
230 volts	230V
277 volts	277V
400 volts	400V
460 volts	460V
480 volts	480V
500 volts	500V

3. Power supply for electronics	Code
Self-powered	SELF
External 115 V supply	115V
External 230 V supply	230V

4. Fan power supply	Code
≤ 100A: No fan	XXXX
≥ 125A: - 115 V fan and	115V
- 230 V fan and	230V

5. Load configuration	Code
Star without neutral	3S
Closed delta	3D

Basic Selection

6. Thyristor fuses	Code
Fuses without fuse blown microswitch	FUSE
Fuses with fuse blown microswitch	MSFU
Without fuses (SWIR)	NONE

7. Firing mode	Code
'Burst mode': base time 16 cycles	C16
base time 64 cycles	C64
'Single-cycle': base time 1 cycle	FC1

8. Input	Code
Analogue signal :	
current from 0 mA to 20 mA	0mA20
current from 4 mA to 20 mA	4mA20
voltage from 0 V to 5 V	0V5
voltage from 0 V to 10 V	0V10

9. Manual language	Code
French	FRA
English	ENG
German *	GER

10. Selected options	Code
Without options: V ² control and End of code	NONE
With options: Selection of options	YES

Control and Alarms options

11. Type 1 Alarms	Code
Partial Load Failure and Serious Alarms	DLF
No Alarms	NONE

12. Load Type	Code
<i>With DLF Option:</i> Short Infrared (with FC1 only) Low temperature coefficientloads	SWIR LTCL
<i>Without DLF option</i>	XXXX

13. Alarm relay contact	Code
<i>With DLF option: closed on alarm</i> open on alarm	NC NO
Without DLF option	XX

Certification et warranty extension

14. NONE

15. Certification	Code
Without certificate	NONE
With certificate	CFMC

16. Warranty extension	Code
Without warranty extension	NONE
Warranty extended to 5 years	WL005

2. Chapter 2

INSTALLATION

Contents	Page
2.1. Safety during installation	2-2
2.2. Mounting	2-3
2.2.1. Types of mounting	2-3
2.2.2. Attachement plates	2-3
2.2.3. Mounting on DIN rails	2-3
2.2.4. Bulkhead mounting	2-4
2.3. Wiring	2-5
2.3.1. General connection diagram	2-5
2.3.2. Power connections	2-7
2.3.2.1. General	2-7
2.3.2.2. Three-phase load configuration diagram	2-7
2.3.3. Control connections	2-8
2.3.3.1. Control terminal blocks	2-8
2.3.3.2. Control signal	2-9
2.4. Alarm relay contact	2-9
2.5. External power supply terminal block	2-10
2.5.1. Power supply for electronics	2-10
2.5.2. Power supply for the fan	2-10
2.5.3. Power supply for electronics and fan	2-11

2. Chapter 2 INSTALLATION

2.1. SAFETY DURING INSTALLATION (MOUNTING AND WIRING)

Danger!



- 7200A power thyristor units must be installed and wired by qualified staff authorised to work on low voltage industrial electrical facilities.

- Units must be installed in a fan-cooled cabinet, to ensure that condensation and pollution are excluded, with a class of at least 2 according to IEC 60664.

We recommend fitting fan-cooled cabinets with a fan failure detection device or a thermal safety cut-out.

The cabinet must be closed and connected to the protective earth according to IEC 60364 or applicable national standards.

Important!



- Units must be mounted with the heatsink positioned vertically, and with no obstructions above or below the unit which could reduce or hamper air flow. If several units are fitted in the same cabinet, arrange them such that air from one unit is not drawn in by the unit above.

The ambient temperature beneath the unit must not exceed 45°C.
Leave a gap of at least 10 mm between adjacent units.

Important!



- Nominal currents correspond to use at ambient temperatures of no more than 45°C. Overheating may cause incorrect operation and may even lead to components being damaged.

Danger!



- It is the user's responsibility to wire and protect the facility according to best practice and applicable standards.

A suitable device, ensuring that the unit can be electrically isolated from the supply, must be installed upline to enable work to be performed safely.

Conductor cross-sections should comply with IEC 60943.

Only use copper cables and wires rated for use at 75 °C.

- Before connecting or disconnecting the unit check that power and control cables and leads are isolated from voltage sources.

The protective earth must be connected before any other connections are made and should be the last cable to be disconnected.

The protective earth connection terminal is marked with the symbol:



To ensure the electrical safety and the earth protection continuity, the front panel screws must be screwed in correctly to the coupling torque of 0.5 Nm



Important!

- To ensure that 7200A power thyristor units comply with Electromagnetic Compatibility requirements, ensure that the panel or DIN rail to which they are attached is correctly grounded.

The ground connection, designed to ensure **ground continuity**, is not in any way a substitute for the protective earth connection.

2.2. MOUNTING

2.2.1. TYPES OF MOUNTING

- DIN rail mounting and bulkhead mounting - 16 A to 63 A only
- Bulkhead mounting with screws \geq 80 A

DIN rail mounting (\leq 63 A only)		Bulkhead mounting	
Attachment plate Two horizontal plates	DIN rail Two symmetrical rails EN 50022	Attachment plate Two horizontal plates	Screws 4 \times M4 (\leq 63 A) 4 \times M6 (\geq 80 A)

Table 2-1 Attachment details for both mounting types

2.2.2. ATTACHMENT PLATES

Two factory-fitted attachment plates on the rear of the 7200A thyristor units are used:

- to clip the unit to a DIN rail, or
- to screw the unit to a bulkhead.

Each attachment plate has:

- attachment holes for bulkhead mounting, and
- two fixed hooks and two mobile hooks for clipping to a DIN rail. (the mobile hooks are moved using a catch and spring).

2.2.3. MOUNTING ON DIN RAILS

For **DIN rail** mounting:

- fix two symmetric DIN rails (for units rated 16 A to 63 A) in accordance with the unit dimensions and safety recommendations.
- bring the unit up against the top rail, engaging the two fixed hooks on the top attachment plate
- push the unit against the rail
- clip the unit onto the bottom rail using the mobile hooks on the bottom attachment plate, ensuring that they are properly engaged.

To **remove** the unit:

- move the mobile hooks downward by pulling the catch on the bottom attachment plate
- unclip the unit from the rail.

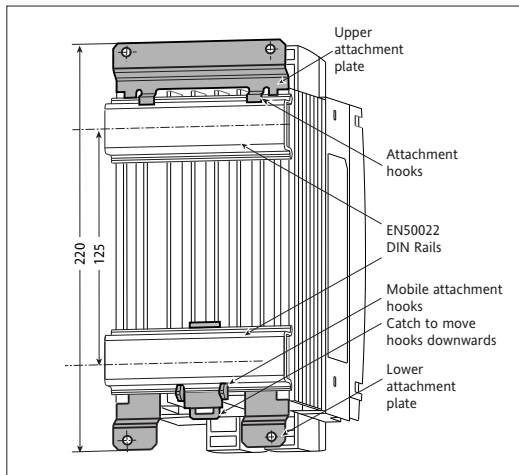

Figure 2-1 Rails DIN attaching.

2.2.4. BULKHEAD MOUNTING

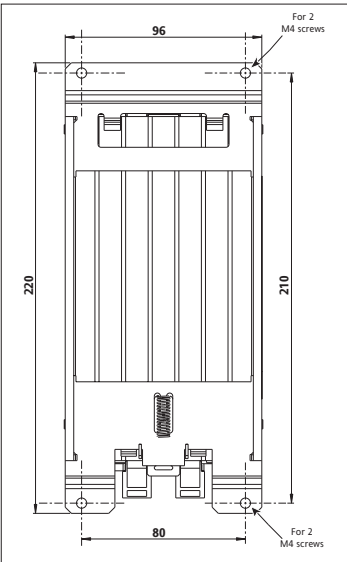

Figure 2-2 Bulkhead mounting - 16 A to 63 A units

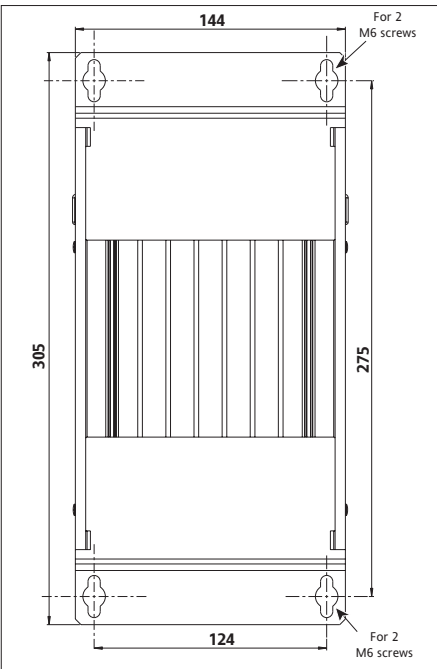

Figure 2-3 Bulkhead mounting - 80 A to 100 A units

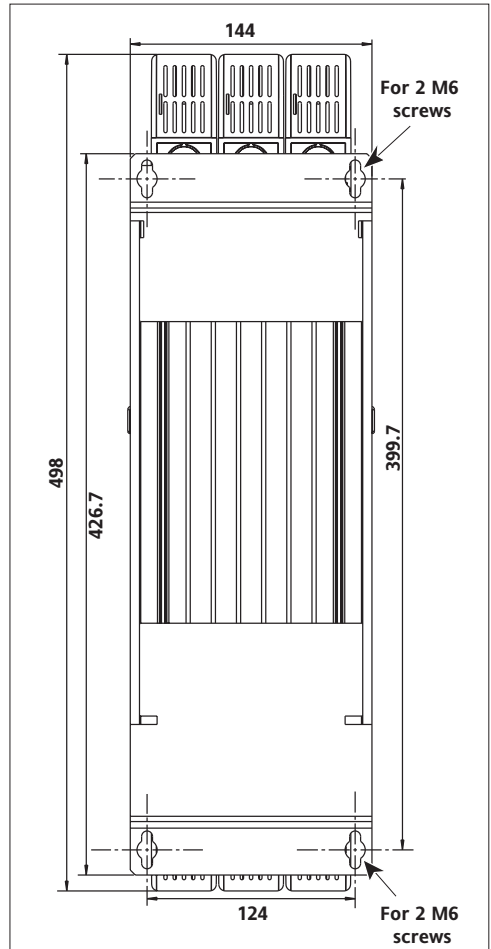

Figure 2-4 Bulkhead mounting - ≥ 125 A units

2.3. WIRING

2.3.1. GENERAL CONNECTION DIAGRAM

The general connection diagram shows the power terminals (independently of the three-phase load configuration) and control connectors.

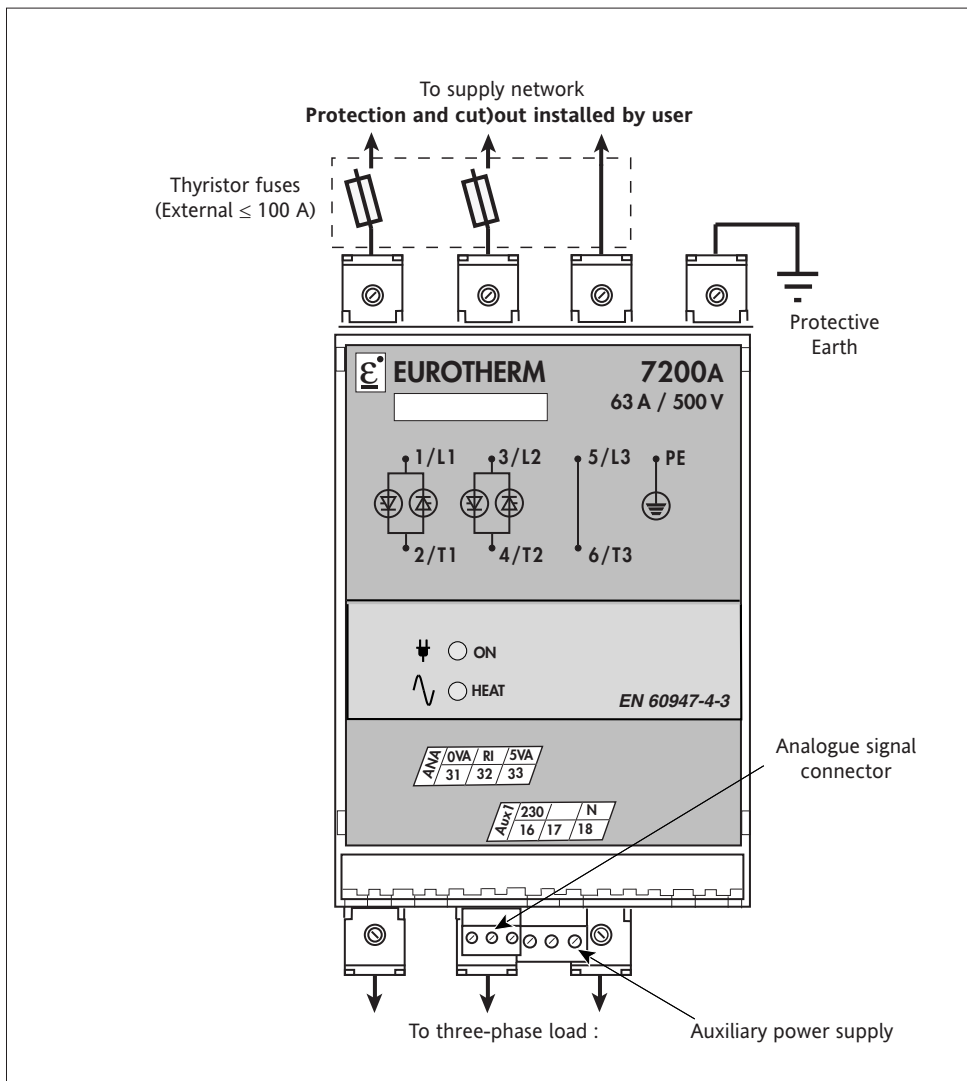

Figure 2-5 General connection diagram for units ≤ 100 A

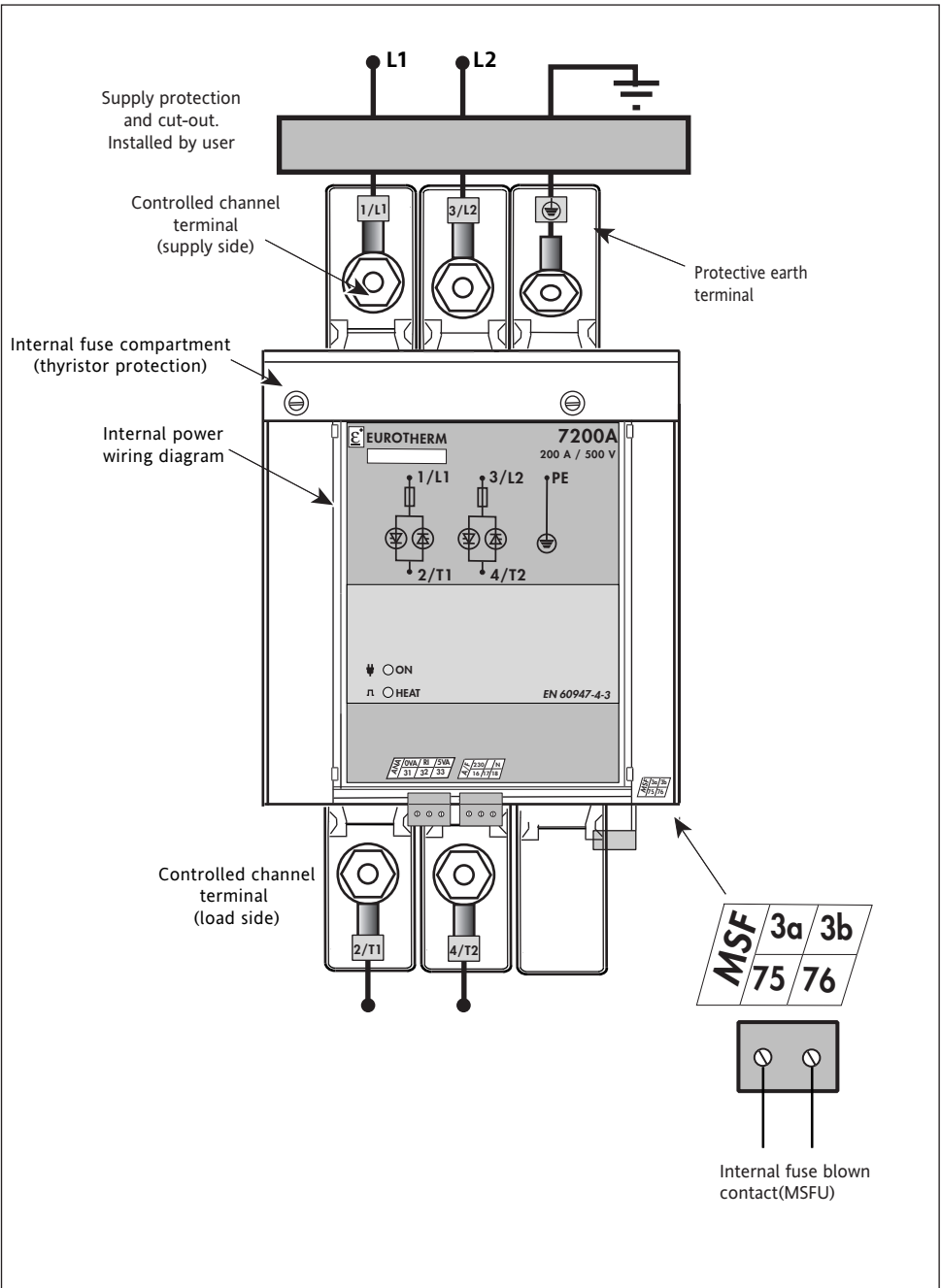

Figure 2-6 General connection diagram for units with rating ≥ 125 A

2.3.2. POWER CONNECTIONS

2.3.2.1. General (Ratings from 16 A to 200 A)

7200A power thyristor units comprise two channels controlled by thyristors. Terminals 1/L1, 3/L2 and 5/L3 must be wired to the three-phase supply network. Terminals 2/T1, 4/T2 and 6/T3 must be wired to the three-phase load. The protective earth terminal PE (earth symbol) must be wired to the protective earth.

Ratings A	Terminal Capacity		Clamping torque Nm	Stripping length mm
	mm ²	AWG		
16 à 25	2,5 à 6	13 à 9	1,2	13
40 à 63	6 à 16	9 à 5	1,8	13
80 à 100	16 à 35	5 à 2	3,8	20

Ratings A	Terminal Capacity		Clamping torque Nm	Crimp eyelet
	mm ²	AWG		
125	50 à 120	0	16,4 (or 28,8)	ø 10 (ou ø 12)
160	70 à 120	00	M10 nut (17 wrench)	
200	95 à 120	000	to attach eyelet and terminal	

Table 2-2 Power wiring details for ratings from 16 to 200 A

NOTE : Conductor cross-sections should comply with IEC 60943. Power connections to the thyristor unit depend on the load configuration scheme. The following two configuration schemes may be used for three-phase loads:

2.3.2.2. Three-phase load coupling

Power connections to the unit depend on the load configuration. The following two configuration schemes may be used for three-phase loads:

- star without neutral (3 connection wires, code 3S),
- closed delta (3 connection wires, code 3D)

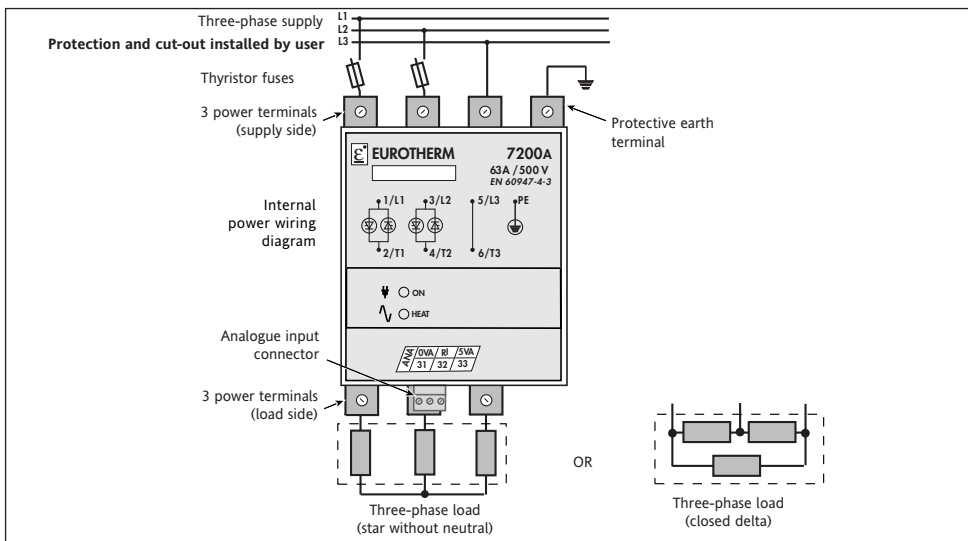

Figure 2-7 Connecting a three-phase load using star without neutral OR closed delta configuration

2.3.3. CONTROL CONNECTIONS

Terminal blocks on the underside of the 7200A power thyristor unit are used to connect:

- the control signals (analogue)
- the auxiliary or electronics supply and the neutral
- alarm relay and acknowledgement contacts

The wires used should be stripped for a length of 6 to 7 mm.

2.3.3.1. Control terminal blocks

The control terminal blocks are plug-in screw connectors.

The terminal blocks available depend on the power thyristor unit version and the selected options in the product code.

The terminal names and numbers are marked on the front panel for available terminal blocks.

The table below gives details of all terminals and terminal blocks.

Version	Terminal block name	Terminal description			Terminal capacity		Torque Nm
		No.	Name	Purpose	mm ²	AWG	
Basic or Options	ANA	31	0VA	0 V for analogue signals '+' for analogue signals	1.5	16	0.5
		32	RI				
33		5VA	5 V user output				
	A/F (except SELF)	16	230	230 V aux. supply	2.5	14	0.7
		17	115	115 V aux. supply			
		18	0V	Neutral or second phase			
Options Alarms	ALR	71	1a	Alarm relay contact (code NC)	2.5	14	0.7
		72	1b				
		73	2a	Alarm relay contact (code NO)			
		74	2b				
High Current ≥ 125 A	MSF	75	3a	Fuse with micro-switch contact	2.5	14	0.7
		76	3b				

Table 2-3 Description of control terminal blocks

2.3.3.2. Control signal

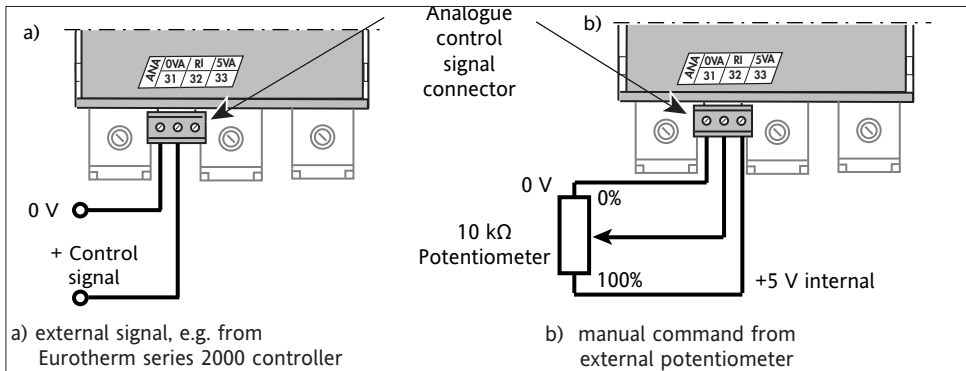

Figure 2-8 Control signal connection (self-powered unit, base version)

The analogue control signal terminal block is labelled **ANA.IN**.

The input available corresponds to the input type selected in the product code (specified range of voltage or current). The signal must be connected between terminals **32** and **31**. The '+' of the control signal must be connected to terminal **32** (labelled **RI**).

A typical external signal connection is shown on figure 2-8a.

Figure 2-8b shows how to use the internal **5 V** voltage (terminal **33** labelled **5VA**) for manual control with an **external 10 kΩ potentiometer**. This voltage (5 V Analogue) is intended for manual control, which is only possible with input code **0V5**.

2.4. Alarm relay contact (alarm option)

If one of the alarm options is fitted, an **alarm relay contact** is available on the 'ALR' terminal block (see figure 2-9).

The type of contact (closed or open on alarm) is determined by the product code. Contact switching capacity: 0.25 A (maximum 250 Vac or 30 Vdc).

Important!

The type of contact (closed or open on alarm) determines the terminal numbers in accordance with standard EN 60947-4-3.

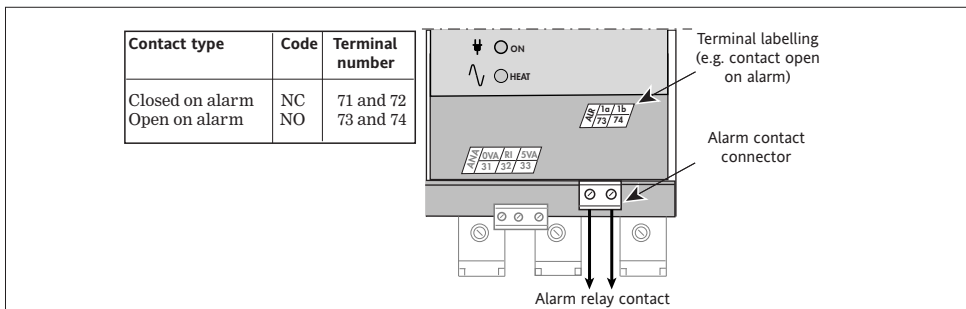

Figure 2-9 Typical alarm relay contact connections

2.5. External power supply terminal block

Power supply for electronics and fan (A/F)

• **The power supply for the electronics** may be either :

- internal (self-powered, code **SELF**) or
- external, **115 V** or **230 V** depending on the product code

Only one terminal (**16** for 230 V or **17** for 115 V) is available depending on the product code.

• **The power supply for the fan :**

For units from 125 A and above, the fan must be powered on with an external power supply **115 V** or **230 V** depending on the product code. The same code A/F is used. (terminal **16** for 230 V or **17** for 115 V depending on the product code)

It also possible to combine the power supply for electronics and the power supply fo the fan, **115 V** or **230 V**(both the same).



In the case of an external power supply for electronics or when combining with the fan power supply, it is necessary to have the power supply in phase or phase opposition with the the voltage between the controlled phases of the unit.

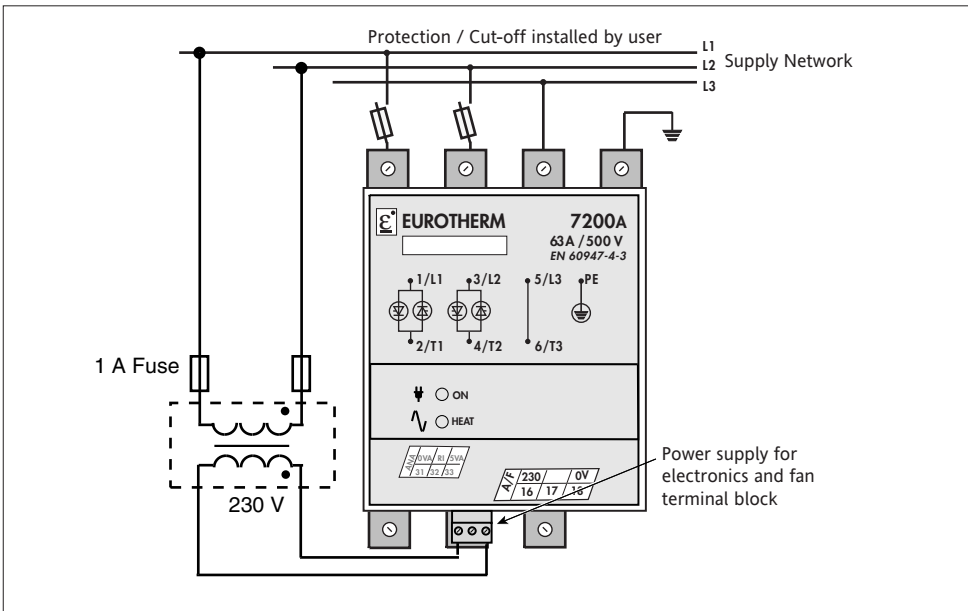

Figure 2-10 Wiring example for the external auxiliary power supply for electronics and the fan (code 230V)

3. Chapter 3

FIRING MODES

Contents	Page
3.1. General and firing mode signalling	3-2
3.2. Burst mode (codes C16 and C64)	3-2
3.3. Single-cycle (code FC1)	3-4

3. Chapter 3 FIRING MODES

3.1. GENERAL AND FIRING MODE SIGNALLING

7200A power thyristor units can be controlled with one of the following thyristor firing types:

- a series of supply voltage cycles with zero crossing firing ('Burst mode', codes C16, C64, FC1)

The firing type is shown on the unit's front panel (table 3-1) in accordance with the product code.

Two indicators (green 'ON' and 'HEAT' LEDs) are included on the front panel in all versions, either basic or with options.

The indicators correspond to the thyristor firing mode as shown in the table below.

LED labelling	Signalling
	Power supply for electronics.
	Thyristor firing request in 'Burst mode' and 'Single-cycle'

Table 3-1 Firing modes and base LEDs on front panel

During normal operation with zero-crossing switching, the 'HEAT' LED flashes to match the thyristor firing periods.

3.2. BURST MODE (codes C16 and C64)

'Burst mode' firing is a **proportional cycle** which delivers a series of **whole supply cycles** to the load.

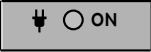
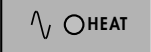
Thyristor firing and cut-off is synchronised with the supply and occurs at **zero** crossing.

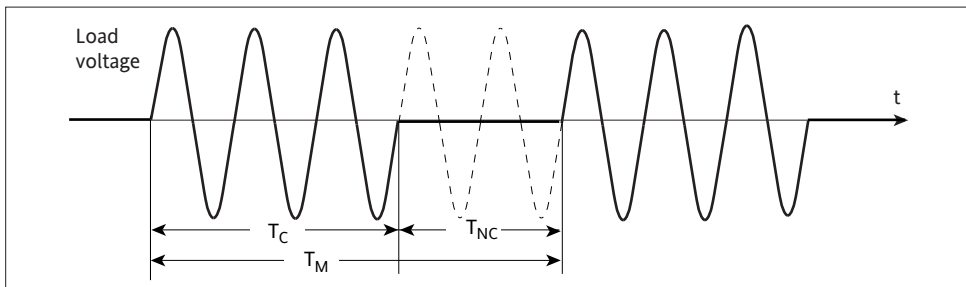

Figure 3-1 Thyristor firing for one of the phases, in 'Burst mode'

Thyristor firing in 'Burst mode' can be described by the firing time (T_C), non-firing time (T_{NF}) and modulation time (T_M); where $T_M = T_C + T_{NC}$

The power delivered to the load is defined by the **duty ratio** $\eta = T_C / T_M$

Firing in 'Burst mode' is defined by the **Base Cycle Time** (T_B).

The Base Cycle Time is equal to the **number of cycles** firing at **50%** of the duty ratio (or 50% of the power supplied to the load): $T_B = T_C = T_{NC}$.

The Base Cycle time is equal to **16 cycles** for code **C16** and **64 cycles** for code **C64**.

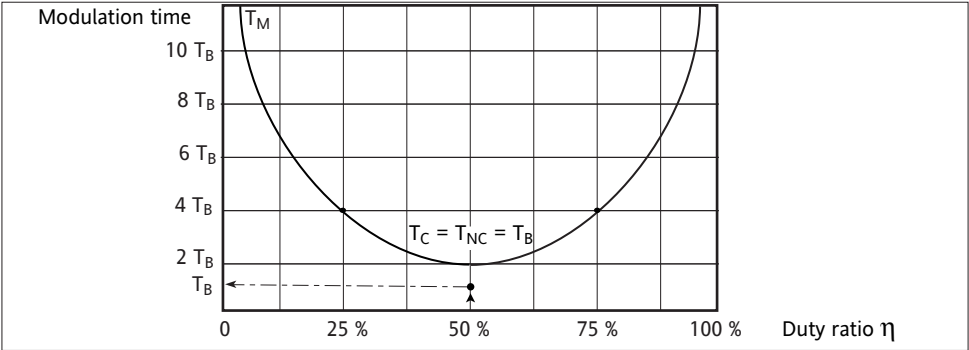

Figure 3-2 'Burst mode' modulation time depending on setpoint

The control system **adjusts** the modulation time to retain the same precision for all duty ratios η (power requested).

3.3. SINGLE-CYCLE (code FC1)

'**Burst mode**' firing with a single firing or non-firing cycle is known as '**Single-cycle**'.

For example, with a setpoint of 50% (corresponding to a duty ratio $\eta = 50\%$) the modulation comprises 1 firing cycle and 1 non-firing cycle.

For duty ratios $\eta < 50\%$ the **firing time** remains **unchanged** (1 cycle) and the non-firing time increases.

For duty ratios $\eta > 50\%$ the **non-firing time** remains **unchanged** (1 cycle) and the firing time increases.

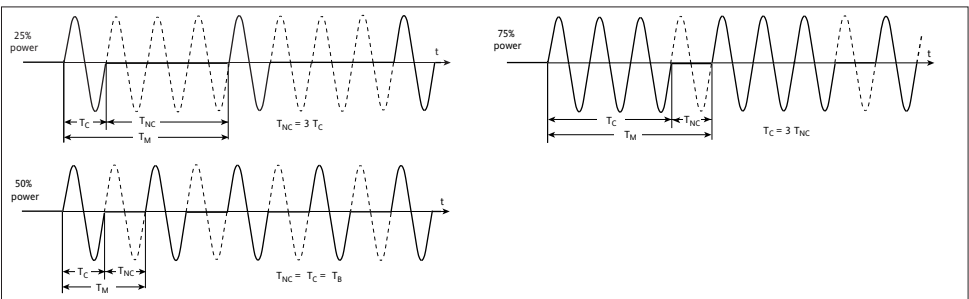

Figure 3-5 Typical firing in 'Single-cycle' mode for various duty ratios

4. Chapter 4

ALARMS

Contents	Page
Alarm diagnostic	4-2
4.1. Safety mechanisms	4-3
4.2. Alarm strategy	4-3
4.2.1. Types of alarm	4-2
4.2.2. Alarm actions	4-2
4.2.2.1. Firing cut-off	4-2
4.2.2.2. Signalling	4-2
4.2.2.3. Alarm priority	4-2
4.2.2.4. Alarm relay	4-2
4.2.2.5. Memorisation	4-3
4.3. Type 1 alarms	4-4
4.3.1. DLF option (Load failure diagnostic alarm)	4-4
4.3.1.1. Alarm actions with DLF option	4-5
4.3.2. PLF diagnostic detection specifications	4-5
4.3.2.1. Setting the DLF alarm	4-5
4.3.2.2. PLF detection conditions	4-6
4.3.2.3. PLF detection sensitivity	4-6
4.3.2.4. Load type matching	4-6
4.3.2.5. Signalling of channel for load fault	4-7
4.3.2.5.1. Disabling alarms for load failure signalling ..	4-7
4.3.2.5.2. Functions of DLF alarm push button	4-8

ALARM DIAGNOSTIC

The table below summarises all status LED information needed to **diagnose the fault**.

OPTIONS ▶	Basic Version	T°	DLF		
LEDs (Front panel) ▼					
-T° Red		≥ 125 A			
GRF Red					
DLF Orange					
ON green					
HEAT Green					
DIAGNOSIS:	↓ No Alarm Firing : Zero crossing	↓ Over-heating Firing STOPPED	↓ Thyristor short-circuit	↓ Total Load Failure	↓ Partial Load Failure

Figure 4-1 Diagnosing operation and alarms according to front panel LED status

4. Chapter 4 ALARMS (Options)

4.1. SAFETY MECHANISMS

The alarms on the 7200A protect the thyristors and the load against certain types of abnormal operation and provide the user with information about the type of fault.



- Alarms are not under any circumstances a replacement for personnel protection.
 - The user is responsible for installing independent safety mechanisms which must be inspected regularly. Given the value of the equipment controlled by the 7200A, this is strongly recommended.
- Eurotherm can supply various types of suitable alarm detector.

Danger

4.2. ALARM STRATEGY

4.2.1. TYPES OF ALARM

Two types of alarm are available **as options** :

- monitoring of load and thyristors

4.2.2. ALARM ACTIONS

4.2.2.1. Firing cut-off

When 'Overheating' fault is detected (for current ratings ≥ 125 A only)

4.2.2.2. Signalling

All faults detected are **signalled** by illuminating or flashing the corresponding LEDs. The LEDs are located on the front panel of the thyristor units beneath the product code. The LEDs present are determined by the option selected.

4.2.2.3. Alarm priority

Only one alarm is signalled if several faults occur simultaneously. Thermal faults and thyristor short-circuits **take priority** over load fault display.

4.2.2.4. Alarm relay

All alarms change the position of the Alarm relay contact. Depending on the product code this contact may be **open** on alarm (code NO) or **closed** on alarm (code NC). The alarm contact switching capacity is **0.25 A** (230 Vac or 32 Vdc).

4.2.2.5. Memorisation

Alarms (except Neutral cut-off) are **not memorised**. After an alarm has been detected, and once the fault conditions have cleared, signalling for these alarms (LED and relay) returns to the non-alarm position.

Thyristor short-circuit and neutral cut-off require repairs.

4.3. ALARMS

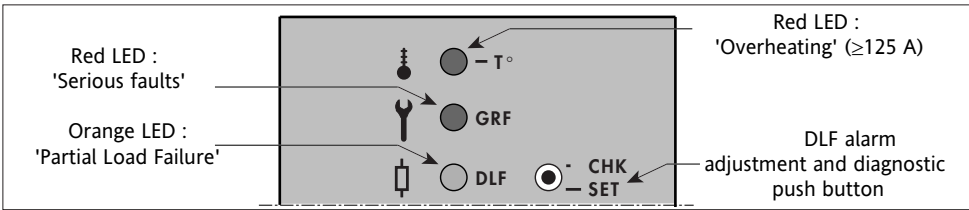

Figure 4-2 Layout of front panel LEDs

4.3.1. DLF OPTION (Load failure Diagnostic alarm)

Alarms monitored with DLF option

With the '**DLF**' option (**D**iagnostic **L**oad **F**ailure alarm) the following **faults** are monitored and diagnosed:

- **P**artial **L**oad **F**ailure, **PLF**
- **S**erious faults
 - **T**otal **L**oad **F**ailure, **TLF**
 - **T**hystistor **S**hort **C**ircuit, **THSC**
 - **T**hystistor overheating, **T°** (only for fan-cooled units with current rating ≥ 125 A).

- Note:**
- Thermal faults are **signalled** by the '**T°**' LED if one of the alarm options or one of the control options (except V2 and OL) is fitted. The unit is **protected** against thermal faults whether or not they are signalled.
 - Thermal faults are signalled by the alarm relay **if** one of the alarm options is fitted.

4.3.1.1. Alarm actions with DLF option

The detection of a fault (PLF or serious alarm) is signalled by :

- the corresponding **LED** on the front panel of the unit
- the alarm relay **contact**

Note : DLF alarms are **not memorised**.

Fault	LED states				Firing stopped	Typical reaction time
	'T°' red	'GRF' red	'DLF' orange	'HEAT' green		
Partial load failure (PLF)	Off	Off	Flashing	On or Flashing	No	1 s to 13 s
Total load failure (TLF)	Off	On	Flashing			
Thyristor short-circuit (THSC)	Off	On	Off	Off	No	
Overheating (T°)	On	Off	Off	Off	Yes	

Table 4-1 LEDs for fault

4.3.2. PLF Diagnostic detection specifications

4.3.2.1. Setting the DLF alarm

Adjusting PLF detection involves calculating and storing the value of the reference impedance from the measured rms current and voltage values.

This can be set using the **push button** on the front panel. The PLF detection setting can only be **adjusted automatically** (reference impedance recalculated) in the following **conditions**:

- rms voltage across load greater than **40%** of the unit's nominal voltage
- rms unit's line currents (going through the unit) are greater than **30%** of the unit rated current
- no over-temperature, over-current or thyristor short-circuit faults or type 3 alarms.
- Each time PLF setting is required, the load must be balanced
- In order to guarantee the sensibility full scale, settings must be done at the load's nominal temperature.



The PLF detection settings should be adjusted each time the thyristor unit is recalibrated.

4.3.2.2. Partial load failure detection

PLF monitoring involves **comparing** the load impedance with a **reference impedance** stored during setting (the load impedance is calculated from the rms values **measured** continuously). This comparison allows the detection of the load impedance increase.

PLF **detection** is only possible under the following **conditions**:

- rms voltage across load greater than **40%** of the nominal voltage, and
- rms unit's line currents are greater than **5%** of the unit's rated current.
- no over-temperature, over-current or thyristor short-circuit faults.

TLF (Total Load Failure) detection is only possible under the following **conditions** :

- rms voltage across load greater than **40%** of the nominal voltage or greater than the unit nominal voltage.
- no over-temperature, over-current or thyristor short-circuit faults.

4.3.2.3. Partial load failure detection sensitivity

Partial load failure detection sensitivity can be expressed in terms of a **maximum number** of load elements connected in parallel for which the unit can detect the failure of one element.

The DLF diagnostic alarm **guarantees** that failure of **One** element will be detected for **two, three or four** (see table 4-2) identical elements connected in parallel for **any** three-phase load configuration scheme.

Load configuration \ Firing mode	3D	3S
FC1	1/2	1/3
C16, C64	1/3	1/4

Table 4-2 Partial load failure detection sensitivity

4.3.2.4. Load type matching

PLF detection is **adapted** to the load type.

The type of load controlled is selected when ordering, with the product code:

- **LTCL** (Low Temperature Coefficient Load), or
- **SWIR** (Short Wave InfraRed elements)

PLF detection, when using **SWIR** type of loads, is only authorised when using **FC1** firing mode

4.3.2.5. Signalling of channel for load fault

With the 'DLF' option the DLF LED **flashes** in particular ways to indicate the controlled channel on which load failure has occurred.

Figure 4-3 shows the **three types of flashing** if a load failure is detected on one of the channels of the 7200A power thyristor unit.

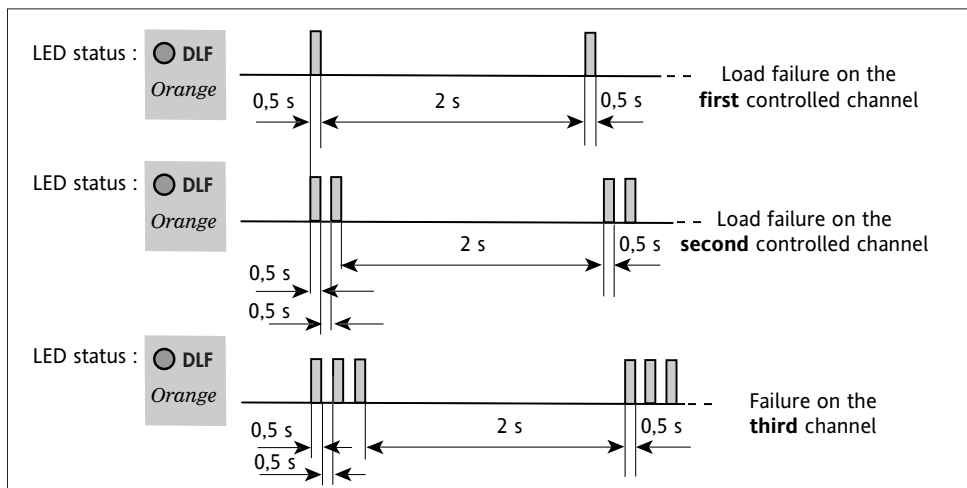

Figure 4-3 Signalling of channel for load failure on the 'DLF' LED

Important!

- The **number** of times the 'DLF' LED flashes indicates the thyristor channel **number** connected to the failed load **phase**.
- In **3S**, three-phase load configuration, the load phase connected to the channel indicated by the 'DLF' LED is failed.
- In **3D** three-phase load configuration, the failure is on one (or two) branch(es) of the delta connected to the channel indicated by the 'DLF' LED.
- If several faults occur simultaneously on the 3 phase-load (2 or 3 phases in 3S, 2 or 3 brached in 3D) then the indications follow each other for each channel

4.3.2.5.1. Disabling alarms for load failure signalling

PLF fault signalling ('DLF' indicator and relay) can be temporarily **excluded** from alarms by pressing the '**CHK / SET**' (**C**heck / **S**etting) push button.

If the fault persists, DLF signalling returns to the alarm position.

4.3.2.5.2. Functions of DLF alarm push button

The push button on the front panel of the unit with the 'DLF' option is labelled 'CHK / SET' (Checking / Setting).

Pushing this push button as shown on the diagrams below sets and diagnoses the status of the PLF detection circuit.

Setting request

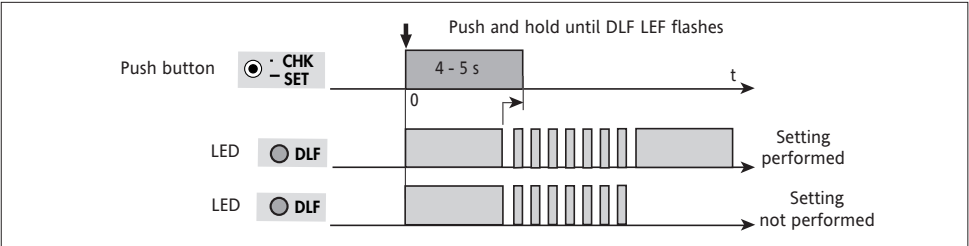

Figure 4-4a PLF detection setting request

Diagnostic

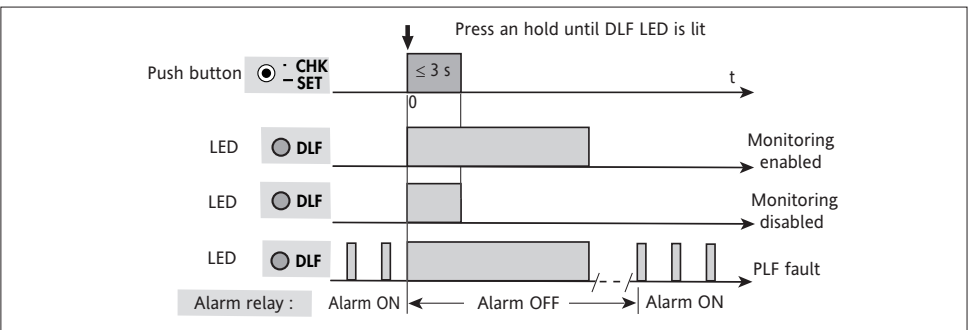

Figure 4-4b PLF monitoring diagnosis

Disabling

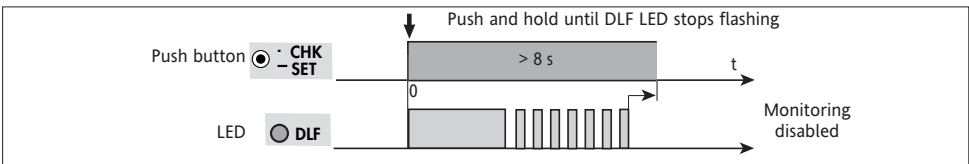

Figure 4-4c Disabling PLF monitoring

Chapter 5

5. MAINTENANCE

Contents	Page
5.1. Safety during maintenance	5-2
5.2. Maintenance	5-2
5.3. Thyristor protection fuses	5-3

5. Chapter 5 MAINTENANCE

5.1. SAFETY DURING MAINTENANCE

Please read carefully before commissioning the thyristor unit

Important!



- Eurotherm shall not be held responsible for any damage, injury, losses or expenses caused by inappropriate use of the product or failure to comply with this manual.
- Accordingly the user is responsible for checking, before commissioning the unit, that all the nominal characteristics correspond to the conditions under which it is to be installed and used.

Danger!



- The product must be commissioned and maintained by qualified personnel, authorised to work in an industrial low voltage environment. Users must not attempt to access internal parts. The heatsink temperature may exceed 100°C. The heatsink remains hot for approx. 15 minutes after the unit is shut down. Avoid touching the heatsink even briefly while the unit is operating.

5.2. MAINTENANCE

- Every six months, check that the power and protective earth cables are correctly **tightened**.
- If the load parameters **change**, the operation of the PLF detection must be diagnosed (see 'DLF option' section).
- If a **DLF alarm** occurs, check the load wiring and condition of contacts. Use the push button to **confirm** the DLF alarm **diagnosis**.
- To ensure that the unit is cooled correctly, the heatsink should be **cleaned** regularly, depending on how dirty the environment is, as should the fan protection grille for fan-cooled units rated at 125 A or more.

Danger!



The thyristor unit should be cleaned only when powered down and at least 15 minutes after stopping operation.

5.3. THYRISTOR PROTECTION FUSES

The thyristors in the 7200A power thyristor unit are protected against excess currents by high-speed fuses (for all load types other than short wave infrared elements).

For current ratings ≤ 100 A the fuses are **external**.

Danger!



High-speed fuses do not provide protection for the installation.
Upline protection must be fitted (non-high-speed fuses, circuit breakers, cut-outs).

The product code specifies whether or not a fuse is present.

With the **FUSE** or **MSFU** (Micro Switch **FU**se) codes, fuses and fuse-holder assembly (corresponding to the current rating) are supplied with the product.

- for code **FUSE**, the fuses is not fitted with a **striker bar**. With this option, 2 lots (fuse + fuse-holder) are delivered (one per contrlled lines.)
- for code **MSFU**, the fuses has a **striker bar** and the fuse-holder is fitted with a blown fuse **microswitch**.

If the user does not order a thyristor protection fuse or if a short wave infrared load is used, **no fuse is supplied** (code **NONE**).

Rating	External fuse part number	Fuse and fuse-holder assembly						
		Part Number		Dimensions (mm)				
		H	x	L	x	P		
16 A	CH260034	FU1038/16A	x2	86.5	x	35	x	64.5
25 A	CH260034	FU1038/25A	x2	86.5	x	35	x	64.5
40 A	CH330054	FU1451/40A	x2	107	x	53	x	76.5
63 A	CS173087U080	FU2258/63A	x2	126.5	x	70	x	76.5
80 A	CS173087U100	FU2258/80A	x2	126.5	x	70	x	76.5
100 A	CS173246U160	FU2760/100A	x2	146	x	80	x	94

Table 5-1 Fuses without microswitch, recommended for rating 16 A to 100 A (code **FUSE**)

Rating	External Fuse part number with strike bar	Fuse and fuse-holder assembly with microswitch						
		Part Number		Dimensions (mm)				
		H	x	L	x	P		
16 A	CS176513U032	MSFU1451/16A	x2	107	x	53	x	76.5
25 A	CS176513U032	MSFU1451/25A	x2	107	x	53	x	76.5
40 A	CS176513U050	MSFU1451/40A	x2	107	x	53	x	76.5
63 A	CS176461U080	MSFU2258/63A	x2	126.5	x	70	x	76.5
80 A	CS176461U100	MSFU2258/80A	x2	126.5	x	70	x	76.5
100 A	CS176246U125	MSFU2760/100A	x2	146	x	80	x	94

Table 5-2 Fuses with microswitch, recommended for rating 16 A to 100 A (code **MSFU**)

Rating	Internal fuse part number
125 A	CS176762U160 x2
160 A	CS176762U315 x2
200 A	CS176762U315 x2

Table 5-3 Unipolar fuses recommended for rating ≥ 125 A

Important!



For all loads (other than short wave infrared elements), using a thyristor protection fuse **other than** the recommended fuse **voids** the product guarantee.

USER NOTES :

INDEX

	Page		Page
A		M	
Alarms	1-6, Chapt. 4	Maintenance	Chapt 5
Alarm relay contacts	2-8	Mounting	2-3, 2-4
B		P	
Bulkhead mounting	2-4	PLF	4-5
C		Power connection	2-7
CE labelling	iv	Protection	1-7
Coding	1-8	Power	1-5
Commissioning	ii	S	
Control connections	2-4	Standards	iv
Control signal	2-7	Safety	iv
Control terminal block	2-6	Safety during maintenance	5-2
D		Safety during installation	2-2
DLF	4-5	T	
Dimensions	1-5	Technical Specification	1-5
E		Three-phase load connection	2-7
EMC	iv	Type of mounting	2-3
F		U	
Firing modes	1-6, Chapt. 3	Use	1-5
Fuses	5-3	W	
G		wiring	2-5
General connection diagram	Chapt 2		
I			
Indication	1-6		
L			
Load	1-5		

EUROTHERM

For over thirty years **Eurotherm Limited** have been providing an unparalleled level of service and expertise to customers in the control of Processes and Power.

From requirement assessment, through to equipment specification and plant commissioning.

Eurotherm Limited is able to offer expertise and equipment in the following areas:

- Input conditioning
- Process and Temperature Indicators
- Single Loop Process and Temperature Controllers with Programming facilities
- Programmable Multi loop Process Controllers
- Solid State Contactors
- Power Controllers
- Paper and Paperless Data Recorders
- Data Acquisition and Management Instrumentation
- Supervisory Systems (SCADA)
- Process Automation Systems

Eurotherm Limited is part of the of **Invensys plc**, one of the world's leading automation and controls companies.

Eurotherm manufactures at a number of locations in Europe and the USA, and is a major supplier to the world's processing and manufacturing industries.

The company is ISO9000 approved and operates TickIT protocols for software management.

Please contact your local **Sales Office**.

EUROTHERM WORLDWIDE SALES AND SERVICE

AUSTRALIA

Eurotherm Pty. Ltd.
Tel Sydney (+61 2) 9634 8444
Fax (+61 2) 9634 8555
Web : www.eurotherm.com.au

AUSTRIA

Eurotherm GmbH
Tel Vienna (+43 1) 798 7601
Fax (+43 1) 798 7605
Web : www.eurotherm.at

BELGIUM

Eurotherm S.A./N.V.
Tel Moha (+32 0) 85 274080
Fax (+32 0) 85 274081
WEB: www.eurotherm.co.uk

DENMARK

Eurotherm A/S
Tel Frederiksberg (+45 38) 871 622
Fax (+45 38) 872 124

FRANCE

Eurotherm Automation SAS
Tel Lyon (+33) 4 78 66 45 00
Fax (+33) 4 78 35 24 90
WEB: ww.eurotherm.tm.fr

GERMANY

Eurotherm Regler GmbH
Tel Limbourg (+49 6431) 2980
Fax (+49 6431) 298119
WEB: www.eurotherm-deutschland.de

HONG KONG

Eurotherm Limited
Tel Hong Kong (+852) 2873 3826
Fax (+852) 2870 0148

INDIA

Eurotherm India Limited
Tel Madras (+9144) 4928129
Fax (+9144) 4928131

IRELAND

Eurotherm Ireland Limited
Tel Naas (+353 45) 879937
Fax (+353 45) 875123

ITALY

Eurotherm SpA
Tel Guanzate (+39 31) 975111
Fax (+39 31) 977512
WEB: www.eurotherm.it

JAPAN

Densei-Lambda KK Eurotherm.
Tel Tokyo (+81 3) 5714 0620
Fax (+81 3) 5714 0621
Web : www.nemic.co.jp

KOREA

Eurotherm Korea Limited
Tel (+82) 31 286 8507
Fax (+82) 31 287 8508

NETHERLANDS

Eurotherm B.V.
Tel Alphen aan den Rijn (+31 172) 411 752
Fax (+31 172) 417 260
WEB:www.eurotherm.nl

NORWAY

Eurotherm A/S
Tel Lysacer (+47) 67 - 59 21 70
Fax (+47) 67 - 11 83 01

SPAIN

Eurotherm España SA
Tel Madrid (+34 91) 6616001
Fax (+34 91) 6619093
WEB: www.eurotherm.es

SWEDEN

Eurotherm AB
Tel Malmo (+46 40) 384500
Fax (+46 40) 384545
WEB: www.eurotherm.se

SWITZERLAND

Eurotherm Produkte AG
Tel Freienbach(+41 055) 4154400
Fax (+41 055) 4154415
Web : www.eurotherm.ch

UNITED KINGDOM

Eurotherm Limited.
Tel. Worthing (+44 1903) 695888
Fax(+44 1903) 695666
WEB:www.eurotherm.co.uk

U.S.A.

Eurotherm Controls Inc.
Tel Leesburg, (+1703) 443-0000
Fax (+1703) 669-1300
WEB: www.eurotherm.com

<http://www.eurotherm.co.uk>

Eurotherm is part of Invensys plc

Equipment made in a certified ISO9001 factory.

© Copyright Eurotherm Limited 2002
All rights strictly reserved. No part of this document may be stored in a retrieval system, or any form or by any means without prior written permission from Eurotherm Limited.
Every effort has been taken to ensure the accuracy of this specification. However in order to maintain our technological lead we are continuously improving our products which could, without notice, result in amendments or omissions to this specification.